

BEST CONTACTS FOR YOUR SUCCESS



Telegärtner

KARL GÄRTNER GMBH

NETWORKING COMPONENTS

COAXIAL CONNECTORS

CABLE ASSEMBLIES

PRECISION TURNED PARTS

PLASTIC INJECTION MOULD PARTS

INDUSTRIAL ELECTRONICS



Coax

TestLine

RF Components for

- Production Line Testing
- Lab Test and Measurement
- Field Test and Measurement

TestLine – RF Components for Test and Measurement

Under the brand name "TestLine", Telegärtner has developed an extensive portfolio for various test and measurement requirements. The TestLine components can be used in lab and field test and measurements as well as production line testing.

Telegärtner has now substantially expanded the range. With the new TestLine 4LL test cables, measurements up to 40 GHz are now possible. Just like the 5LL types, the 4LL test cables offer exceptional electrical properties and mechanical protection.

In the field of precision adaptors and connectors, Telegärtner

offers components for measurements up to 40 GHz. These precision adaptors are types: 2.92 mm, 3.5 mm, SMA and N. For PCB solutions, 2.92 mm and SMA types are offered in End Launch and Edge Mount styles.

Termination loads have been expanded with the 4.3-10 series.

Furthermore Telegärtner offers some particular highlights: A Port Saver to protect the sensitive jacks on the equipment and Quick/ Push-on Adaptors for secure and quick measurements in short intervals.

TestLine Fields of Application

Lab test and measurement

Applications in the laboratory require a high level of quality and precision. For R&D sites and company labs Telegärtner offers solutions for almost every requirement – from high quality measurement cables, through termination loads to precision adaptors.



Production Line Testing

For production line testing in factories and production sites, measurements should be carried out quickly and reliably. In harsh environments, mechanical stability, robustness, and longevity without loss in the signal quality are required.



Field test and measurement

Tests and measurements in the field require resistance to external influences. Also just as crucial are good handling and quick installation in the field.



TestLine Components

TestLine Cables

The high quality TestLine RF measurement cables have a particularly effective cable protection against mechanical stress while at the same time satisfying the highest requirements for electrical transmission characteristics regarding attenuation, phase stability and life span.

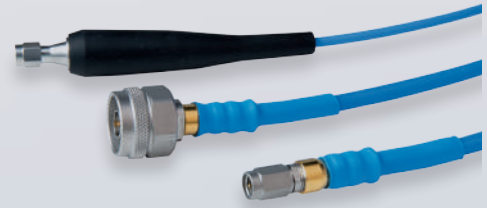

PCB Precision Connectors

PCB precision connectors allow tests and measurements to be carried out on PCBs. This can mostly be found in applications in test labs and R&D sites. Edge mount and End launch versions are available for 2.92 mm and SMA types up to 40 GHz and 27 GHz respectively.

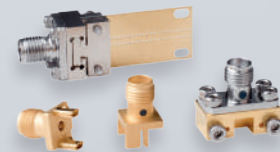

Precision Adaptors

Telegärtner offers a range of high quality 2.92 mm, 3.5 mm, SMA and N precision adaptors for test purposes, which can be used for almost every requirement. The TestLine adaptors are specially designed for a high number of mating cycles and have excellent RF properties.



Quick Push-On Test Adaptors / Port Savers

By using port savers you spare the sensitive jacks on the equipment from wear and tear and avoid the costly exchange of these connectors. The port saver is available for 2.92 mm, SMA, N and 7-16 types.

The use of the Quick/Push-on Test Adaptors allows a marked reduction in connection time. As such, these products lend themselves perfectly to test beds and production lines.



Termination Loads

Telegärtner offers a wide variety of high quality TestLine 4.3-10, 7-16, N, TNC, BNC, SMA and R-SMA termination loads. The termination loads are used to test and terminate RF transmitters and amplifiers.



Attenuators

The Telegärtner TestLine attenuators are used to weaken RF signals. Up to a frequency of 6 GHz, a precise signal attenuation of 3, 6, 10 or 20 dB depending on type is achieved. Application fields for attenuators in test and measurement are where the RF performance needs to be set at certain levels.



TestLine Cables

The TestLine RF Test Cable assemblies have been designed with high specifications regarding attenuation, phase stability and life span for test and measurement purposes. The connectors, which have been specifically designed for this purpose, have a special connection process for low, stable VSWR as well as a particularly effective cable protection against mechanical stress. In addition the connector bodies and nuts are made

from stainless steel, which offers a very high number of mating cycles.

The TestLine cables are therefore perfect for use in lab or production areas, in which a high number of reliable signal tests need to be undertaken.

Telegärtner offers 2 types: 5LL for measurements up to 18 GHz (SMA, N and 7-16) and 4LL for measurements up to 40 GHz (2.92 mm). Each cable is tested separately and delivered with a test report.



Features of the TestLine Cables

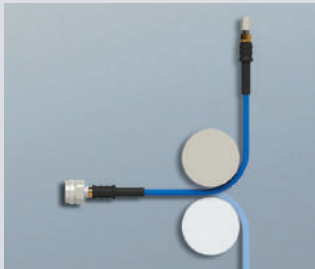

Stability

The special structure of the RF cable with a foam PTFE dielectric guarantees excellent phase stability and return loss stability even when the cable is bent as required.

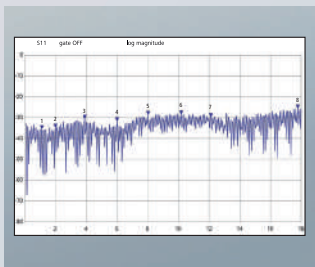

Excellent electrical Values

for frequencies up to 18 GHz (SMA) or 11 GHz (N) with low return loss (-23 dB at 18 GHz). The maximum cable attenuation is only 1.0 dB/m at 18 GHz.

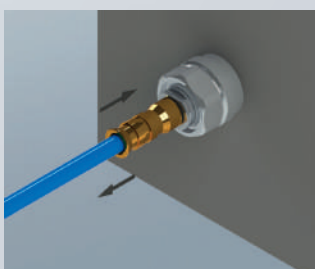

High Number of Mating Cycles

while the transmission properties remain the same thanks to the gold plated centre conductor and a stainless steel body and nut.



100% Tested

Every cable is supplied with a detailed test report.

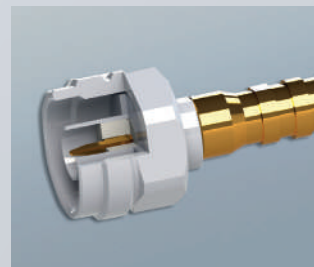

Precision Connector

TestLine cables are manufactured with connectors designed specifically for test and measurement requirements.



Heat resistant and flame retardant

Temperature range
-54 °C bis +135 °C

Construction of TestLine Cables

TestLine Connector Design

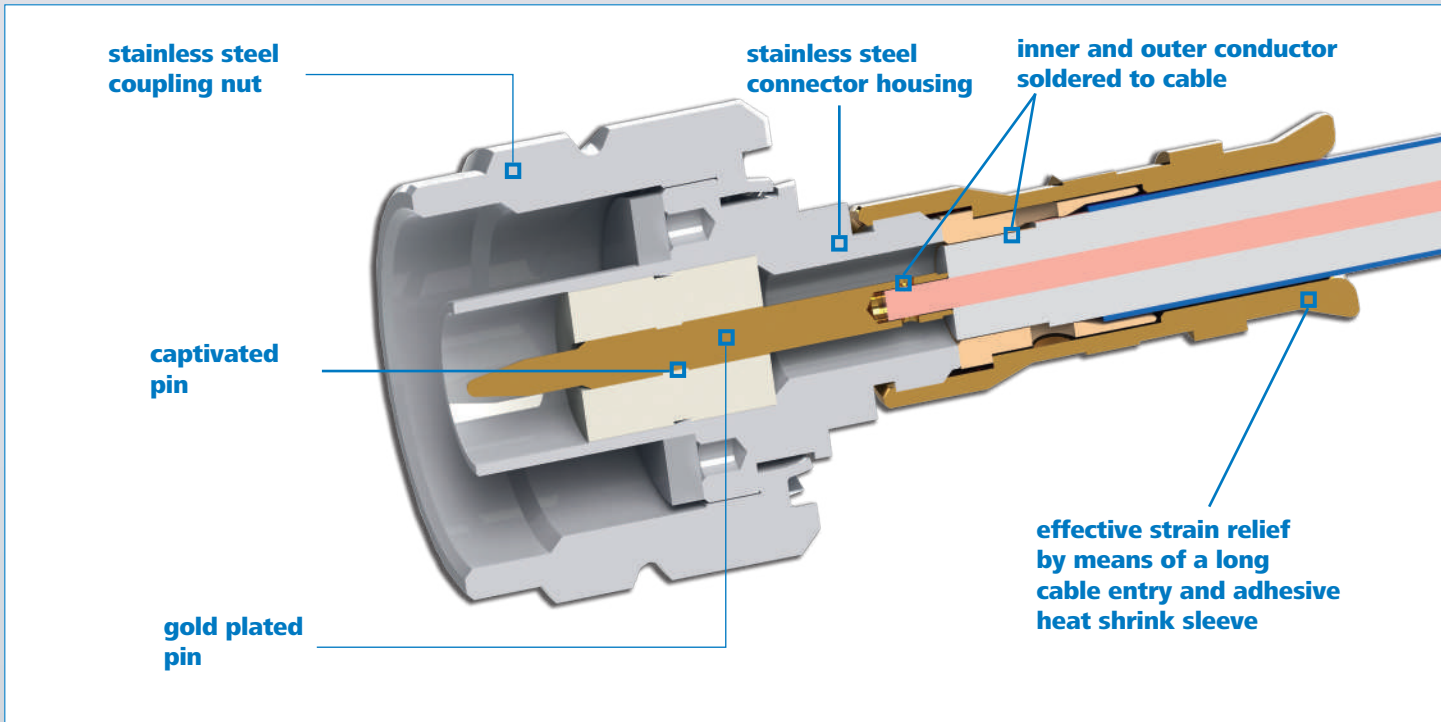

TestLine Cable Construction

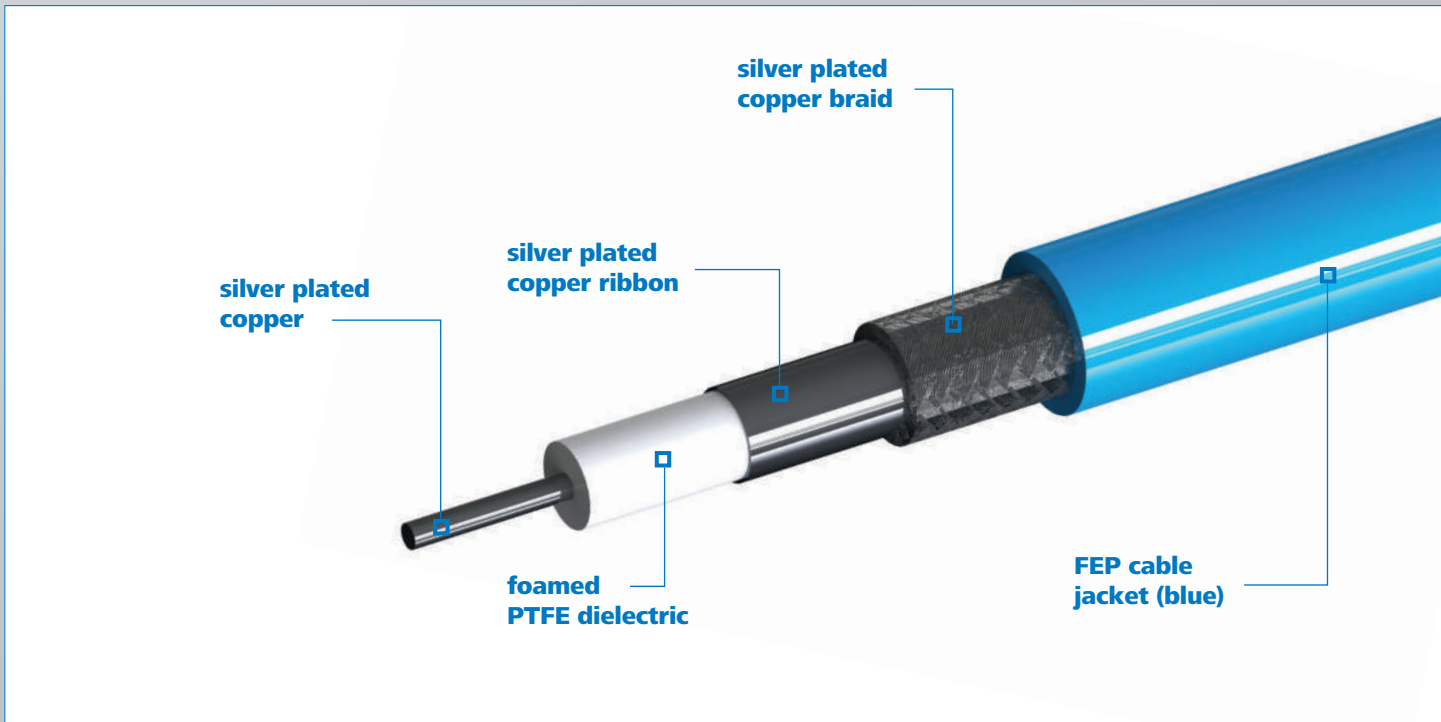

TestLine Cables 4LL 40 GHz

The high quality 4LL test and measurement cables from the Test-Line Series have been designed for RF measurements up to 40 GHz. Thanks to the specially chosen materials and the excellent workmanship, very good attenuation can be achieved at high frequencies. Provided with a solid and stable strain relief, the TestLine 4LL cables are protected at the termination point from high pressure loads.

4LL test and measurement cables are available in standard lengths of 600 mm, 1000 mm and 1500 mm. Special lengths are available on request.

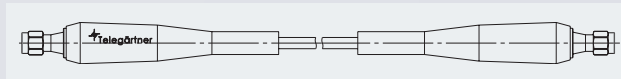

Order no.	Description	Frequency	Length
L00010A1782	TestLine 4LL cable 2.92 – 2.92	40 GHz	600 mm
L00010A1783	TestLine 4LL cable 2.92 – 2.92	40 GHz	1.000 mm
L00011A0480	TestLine 4LL cable 2.92 – 2.92	40 GHz	1.500 mm

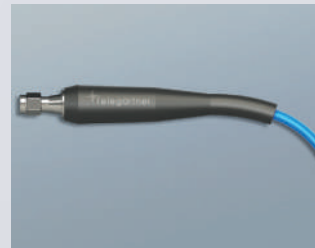

Bend Protection

Due to a specially strengthened strain relief, all 4LL test cables are protected against strain due to sharp bends at the termination point.

Mechanical Characteristics

cable bending radius	> 19 mm
cable sheath	FEP, Ø 4,2 mm
connector center contact	CuBe, gold-plated
connector outer contact	stainless steel
coupling nut	stainless steel
plugging cycles	min. 500
operation temperature	-55 °C to +135 °C

Electrical Characteristics

connector type	2.92mm
impedance	50 Ohm
frequency range	< 40 GHz
return loss (typical)	up to 4 GHz: -33 dB up to 10 GHz: -25 dB up to 18 GHz: -18 dB up to 26 GHz: -18 dB up to 40 GHz: -16 dB
max. cable attenuation (@40GHz)	2,4 dB/m
screen effectiveness	-100 dB max.
phase stability (measured after 90° bend)	< 4° @ 40GHz
insertion loss (dB/m)	0,33 @ 1 GHz 0,99 @ 6 GHz 1,12 @ 10 GHz 1,58 @ 18 GHz 1,94 @ 26 GHz 2,48 @ 40 GHz

Return Loss TestLine Cables 4LL

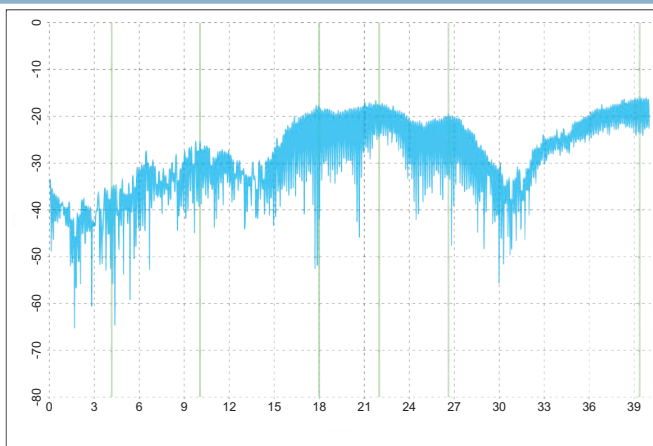

marker	stimulus	value
1	4,161 GHz	-35,14 dB
2	10,055 GHz	-25,40 dB
3	18,000 GHz	-26,69 dB
4	22,000 GHz	-22,92 dB
5	26,609 GHz	-19,66 dB
6	39,357 GHz	-16,15 dB

TestLine Cables 5LL 18 GHz

The TestLine 5LL cables have been specially designed for test processes with constantly changing test subjects and therefore high mating cycles. The high end test cables show excellent transmission properties for the demanding usage in test labs and production tests.

The specially designed 5LL cables from Telegärtner offer extra strong protection against external stresses. The cable protection is made from a spiral steel wire with an extremely high pressure load of up to 80 kg/5 cm of cable length. Damage to the cable by kinking or crushing is thereby minimized.

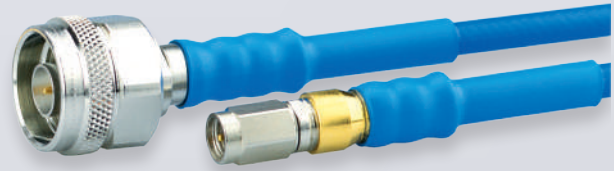
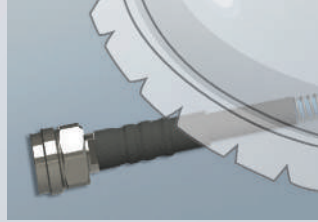
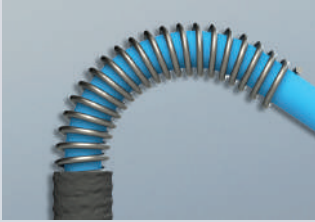



Available standard lengths are 600 mm and 1000 mm. Special lengths on request.

Cable Protection

TestLine Cables have the option of being fitted with a stainless steel wire coil. This coil protects the cable from mechanical stress up to 80 kg/5 cm of cable.

Use of this cable protection is particularly useful in production areas, field tests and also in labs where mechanical stress can't be ruled out.

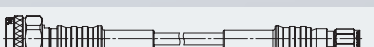
	Order no.	Description	Remarks	Frequency	Length
	L00010A1588	TestLine 5LL cable SMA – SMA	Standard	18 GHz	600 mm
	L00010B1588	TestLine 5LL cable SMA – SMA	with impact protection	18 GHz	600 mm
	L00010A1589	TestLine 5LL cable N – N	Standard	11 GHz	600 mm
	L00010B1589	TestLine 5LL cable N – N	with impact protection	11 GHz	600 mm
	L00010A1590	TestLine 5LL cable N – SMA	Standard	11 GHz	600 mm
	L00010B1590	TestLine 5LL cable N – SMA	with impact protection	11 GHz	600 mm

Mechanical Characteristics

cable bending radius	> 30 mm
cable sheath	FEP, Ø 5,4 mm
connector center contact	CuZn39Pb3, gold-plated
connector outer contact	stainless steel
coupling nut	stainless steel
plugging cycles	min. 1000
operation temperature	-55 °C to +110 °C

Electrical Characteristics

connector types	SMA, N special design
impedance	50 Ohm
frequency range	SMA: < 18 GHz N: < 11 GHz
return loss (typical)	up to 4 GHz: -28 dB up to 10 GHz: -24 dB up to 18 GHz: -20 dB
max. cable attenuation (@40GHz)	1,0 dB/m
screen effectiveness	-110 dB max. (@ 1 GHz)
phase stability (measured after 90° bend)	< 1,5° @ 4 GHz - 18 GHz
insertion loss (dB/m)	0,22 @ 1 GHz 0,41 @ 4 GHz 0,68 @ 10 GHz 0,94 @ 18 GHz

Return Loss TestLine Cables 5LL

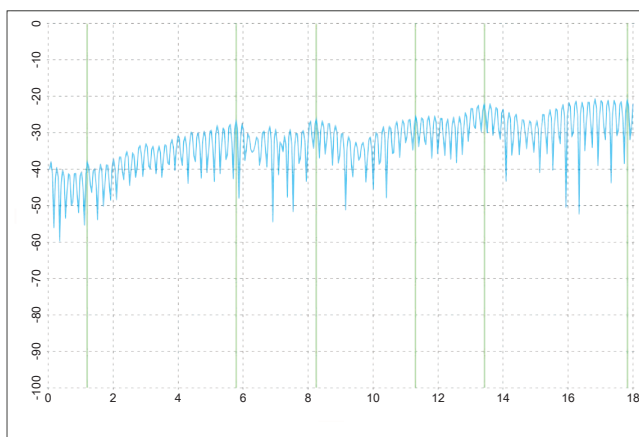



marker	stimulus	value
1	1,200 GHz	-38,52 dB
2	5,790 GHz	-26,84 dB
3	8,250 GHz	-26,84 dB
4	11,300 GHz	-25,88 dB
5	13,430 GHz	-22,69 dB
6	17,830 GHz	-21,40 dB

PCB Precision Connectors

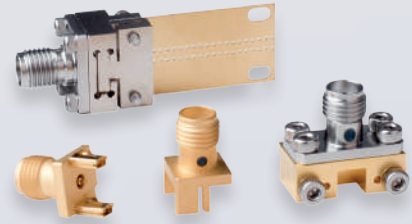
PCB precision connectors are mainly used in R&D applications. With Edge Mount and End Launch Telegärtner offers two different mounting options for this area. Compared to the standard versions, precision connectors are designed for precise measurements at high frequencies. End Launch types are also available in the "Quick" model, which allows the connectors to be connected quickly and repeatedly to the PCB.



Series	Order no.	Description	Type	Return loss (typ.)	Max. frequency
SMA 	J01151A1401	SMA End Launch Solder Type	f	≤ -16 dB	27 GHz
SMA 	J01151A1411	SMA Quick End Launch Quick Push-on Type	f	≤ -14 dB	18 GHz
SMA and 2.92 mm 	J01151A1386	SMA Edge Mount Screw-on Type	f	2 GHz: -23 dB; 11 GHz: -22 dB; 18 GHz: -18 dB; 27 GHz: -15 dB	27 GHz
	J01531A0000	2.92 mm Edge Mount Screw-on Type	f	2 GHz: -24 dB; 11 GHz: -24 dB; 18 GHz: -20 dB; 27 GHz: -15 dB; 33 GHz: -15 dB; 40 GHz: -15 dB	40 GHz

Precision Adaptors

Telegärter has extended its portfolio with high quality precision adaptors, which, depending on the type, can be used in frequency bands up to 40 GHz. They can be used on almost all measuring equipment. All precision adaptors have excellent RF properties and thanks to a stainless steel body, a high number of mating cycles.



Series	Order no.	Description	Type	Return loss (typ.)	Max. frequency
2.92 mm 	J01532A0000	2.92 mm precision adaptor	m-m	2 GHz: -33 dB; 11 GHz: -27 dB; 27 GHz: -25 dB; 40 GHz: -18 dB	40 GHz
	J01532A0001	2.92 mm precision adaptor	m-f	2 GHz: -38 dB; 11 GHz: -27 dB; 27 GHz: -25 dB; 40 GHz: -18 dB	40 GHz
	J01532A0002	2.92 mm precision adaptor	f-f	2 GHz: -38 dB; 11 GHz: -27 dB; 27 GHz: -25 dB; 40 GHz: -18 dB	40 GHz
3.5 mm 	J01522A0000	3.5 mm precision adaptor	m-m	2 GHz: -33 dB; 11 GHz: -27 dB; 18 GHz: -23 dB; 27 GHz: -20 dB	27 GHz
	J01522A0001	3.5 mm precision adaptor	m-f	2 GHz: -33 dB; 11 GHz: -27 dB; 18 GHz: -23 dB; 27 GHz: -20 dB	27 GHz
	J01522A0002	3.5 mm precision adaptor	f-f	2 GHz: -36 dB; 11 GHz: -27 dB; 18 GHz: -23 dB; 27 GHz: -20 dB	27 GHz
SMA 	J01154A0086	SMA precision adaptor	m-m	2 GHz: -33 dB; 6 GHz: -30 dB; 11 GHz: -27 dB; 18 GHz: -27 dB	18 GHz
	J01154A0061	SMA precision adaptor	m-f	2 GHz: -38 dB; 6 GHz: -25 dB; 11 GHz: -23 dB; 18 GHz: -22 dB;	18 GHz
	J01154A0096	SMA precision adaptor	f-f	2 GHz: -40 dB; 6 GHz: -33 dB; 11 GHz: -23 dB; 18 GHz: -20 dB	18 GHz
N 	J01024A0013	N precision adaptor	m-m	2 GHz: -40 dB; 6 GHz: -36 dB; 11 GHz: -32 dB; 18 GHz: -26 dB	18 GHz
N to SMA 	J01027T0018	measuring adaptor N-SMA, 50 Ω	m-f	2 GHz: -40 dB; 6 GHz: -30 dB; 11 GHz: -30 dB; 18 GHz: -20 dB	18 GHz
	J01027T0017	measuring adaptor N-SMA, 50 Ω	f-f	2 GHz: -40 dB; 6 GHz: -28 dB; 11 GHz: -28 dB; 18 GHz: -20 dB	18 GHz
	01027T0019	measuring adaptor N-SMA, 50 Ω	m-m	2 GHz: -40 dB; 6 GHz: -28 dB; 11 GHz: -28 dB; 18 GHz: -20 dB	18 GHz
	J01027T0016	measuring adaptor N-SMA, 50 Ω	f-m	2 GHz: -40 dB; 6 GHz: -28 dB; 11 GHz: -28 dB; 18 GHz: -20 dB	18 GHz

Quick Push-On Adaptor

The Quick/Push-On adaptors can be used wherever reliable measurements have to be carried out in short intervals. Tests can be carried out more effectively through quicker connecting and disconnecting of the test cable. Quick/Push-On adaptors are mostly used in test labs and also on production lines.





Usage of Quick/Push-On Adaptors



Testport



Quick/Push-On Adaptor on Measuring Cable

Series	Order no.	Description	Type	Return loss (typ.)	Max. frequency
SMA 	J01155A0099	SMA Push-On Test Adaptor, 50 Ohm	m-f	1 GHz: -34 dB; 3 GHz: -27 dB; 6 GHz: -27 dB; 10 GHz: -20 dB; 18 GHz: -18 dB	18 GHz
N 	J01024A0010	N Quick Connect Test Adaptor, 50 Ohm	m-f	2 GHz: -35 dB; 6 GHz: -28 dB; 11 GHz: -25 dB	11 GHz
	J01024A0011	N-Push-On Test Adaptor, 50 Ohm	m-f	2 GHz: -35 dB; 6 GHz: -28 dB; 11 GHz: -25 dB	11 GHz

Port Saver

Port savers are used to protect the test ports of expensive test equipment. Swapping out jacks in expensive test equipment is cost-intensive and time-consuming. In order to avoid this, the Telegärtner Port Saver is con-

nected to the original port, so that it doesn't get damaged even when used regularly. The port saver can be replaced quickly and economically when required.



Usage of Port Savers



Jack on the equipment with Port Saver



Measuring Cable

Series	Order no.	Description	Type	Return loss (typ.)	Max. frequency
N 	J01024A0009	N Test Adaptor (Port Saver), 50 Ohm	m-f	2 GHz: -35 dB; 6 GHz: -28 dB; 11 GHz: -25 dB	11 GHz
7-16 	J01123B0006	7-16 Test Adaptor (Port Saver), 50 Ohm	m-f	1 GHz: -43 dB; 2 GHz: -31 dB; 6 GHz: -29 dB	6 GHz

Termination Loads

Termination loads are connected as a load to an open signal output or an RF line in order to avoid reflection. They are available with an impedance of 50 Ohms. The performance spectrum of the termination loads varies between 1 W and 625 W up to maximum frequencies of 18 GHz. Termination loads are used for example on open ports on transmitters as well as in the calibration of RF test equipment.

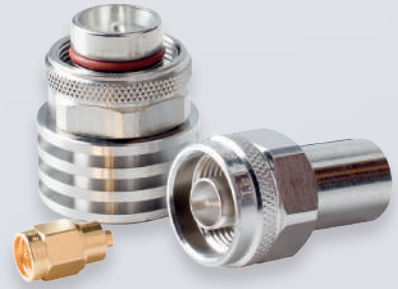

Electrical Characteristics Series SMA / R-SMA

impedance	50 Ω
frequency range	< 18 GHz (SMA) < 6 GHz (R-SMA)
return loss	2 GHz: 34 dB 6 GHz: 23 dB 18 GHz: 17 dB
max. power	1 Watt

Electrical Characteristics Series 4.3-10

impedance	50 Ω
frequency range	< 7,5 GHz
return loss	1,0 GHz: 40 dB 2,5 GHz: 35 dB 7,5 GHz: 21 dB
max. power	2 Watt

Electrical Characteristics Series BNC

impedance	50 Ω
frequency range	< 4 GHz
return loss	4 GHz: 24 dB
max. power	1 res. 2 Watt

Electrical Characteristics Series N







impedance	50 Ω
frequency range	< 18 GHz
return loss	4 GHz: 26 dB 6 GHz: 25 dB 18 GHz: 13 dB
max. power	2 res. 10 Watt

Electrical Characteristics Series TNC

impedance	50 Ω
frequency range	< 6 GHz
return loss	6 GHz: 21 dB
max. power	1 Watt

Electrical Characteristics Series 7-16

impedance	50 Ω
frequency range	< 7.5 GHz
return loss	2.5 GHz: 27 dB
max. power	2 res. 10 Watt

Series	Order no.	Description	Max. Frequency	Max. Power
SMA/R-SMA 	J01152A0011	SMA termination load, plug	6 GHz	1 W
	J01152B0011	SMA termination load, plug	18 GHz	1 W
	J01152R0011	R-SMA termination load, plug	6 GHz	1 W
SMC 	J01176A0001	SMC termination load, jack	2 GHz	1 W
BNC 	J01006A0020	BNC termination load, plug	4 GHz	1 W
	J01006A0021	BNC termination load, jack	4 GHz	1 W
TNC 	J01016A0002	TNC termination load, plug	6 GHz	1 W
	J01016A0003	TNC termination load, jack	6 GHz	1 W
N 	J01026A0012	N termination load, plug	6 GHz	1 W
	J01026A0010	N termination load, plug	18 GHz	2 W
	J01026A0013	N termination load, jack	6 GHz	1 W
	J01026A0014	N termination load, jack	18 GHz	2 W
	J01026A0011	N termination load, plug	18 GHz	10 W
7-16 	J01124A0001	7-16 termination load, plug	7.5 GHz	2 W
	J01124A0002	7-16 termination load, jack	7.5 GHz	2 W
	J01124A0003	7-16 termination load, plug	7.5 GHz	10 W
	J01124A0004	7-16 termination load, jack	7.5 GHz	10 W
4.3-10 	J01444A0000	4.3-10 termination load Screw	7,5 GHz	2 Watt
	J01444A0001	4.3-10 termination load Screw	6,0 GHz	1 Watt
	J01444A3000	4.3-10 termination load Push-Pull	7,5 GHz	2 Watt

Attenuators

Telegärtner attenuators are used to weaken RF signals. Up to a frequency of 6 GHz, a precise signal attenuation of 3, 6, 10 or 20 dB depending on type is achieved. Application fields for attenuators are in Antenna Lines (e.g. Mobile Communications and WiFi) and in test and measurement where the RF performance needs to be set at certain levels.



Electrical Characteristics Series SMA	
impedance	50 Ω
frequency range	6 GHz
return loss	1 GHz: 30 dB 3 GHz: 25 dB 6 GHz: 20 dB
max. power	2 Watt







Electrical Characteristics Series N	
impedance	50 Ω
frequency range	6 GHz
return loss	1 GHz: 30 dB 3 GHz: 25 dB 6 GHz: 20 dB
max. power	2 Watt

Electrical Characteristics Series BNC	
impedance	50 Ω
frequency range	6 GHz
return loss	1 GHz: 30 dB 3 GHz: 25 dB 6 GHz: 20 dB
max. power	2 Watt

Electrical Characteristics Series R-TNC	
impedance	50 Ω
frequency range	6 GHz
return loss	1 GHz: 30 dB 3 GHz: 25 dB 6 GHz: 20 dB
max. power	2 Watt

Electrical Characteristics Series TNC	
impedance	50 Ω
frequency range	6 GHz
return loss	1 GHz: 30 dB 3 GHz: 25 dB 6 GHz: 20 dB
max. power	2 Watt

Electrical Characteristics Series R-SMA	
impedance	50 Ω
frequency range	6 GHz
return loss	1 GHz: 30 dB 3 GHz: 25 dB 6 GHz: 20 dB
max. power	2 Watt

Series	Order no.	Description	Attenuation nominal
SMA 	J01156A0011	SMA attenuator, male-female	3 dB
	J01156A0021	SMA attenuator, male-female	6 dB
	J01156A0031	SMA attenuator, male-female	10 dB
	J01156A0041	SMA attenuator, male-female	20 dB
BNC 	J01006A0022	BNC attenuator, male-female	3 dB
	J01006A0023	BNC attenuator, male-female	6 dB
	J01006A0024	BNC attenuator, male-female	10 dB
	J01006A0025	BNC attenuator, male-female	20 dB
TNC 	J01016A0004	TNC attenuator, male-female	3 dB
	J01016A0005	TNC attenuator, male-female	6 dB
	J01016A0006	TNC attenuator, male-female	10 dB
	J01016A0007	TNC attenuator, male-female	20 dB
N 	J01026A0018	N attenuator, male-female	3 dB
	J01026A0019	N attenuator, male-female	6 dB
	J01026A0020	N attenuator, male-female	10 dB
	J01026A0021	N attenuator, male-female	20 dB
R-TNC 	J01016R0004	R-TNC attenuator, male-female	3 dB
	J01016R0005	R-TNC attenuator, male-female	6 dB
	J01016R0006	R-TNC attenuator, male-female	10 dB
	J01016R0007	R-TNC attenuator, male-female	20 dB
R-SMA 	J01156R0011	R-SMA attenuator, male-female	3 dB
	J01156R0021	R-SMA attenuator, male-female	6 dB
	J01156R0031	R-SMA attenuator, male-female	10 dB
	J01156R0041	R-SMA attenuator, male-female	20 dB

More Customised: assembling RF cables online

Do you want to assemble RF cables with coaxial connectors individually and add strain relief, labelling and cable length according to your requirements? Then the COAX configurator developed by Telegärtner is just what you need:

- ... **simple**, and is available to you around the clock
- ... **fast**, and allows you to configure your customised assembly with just a few clicks, thanks to a logical and easy-to-understand user-guidance
- ... **user-orientated**, and offers you exactly the information you require in order to configure your individual cable assembly



User-friendly input mask ...

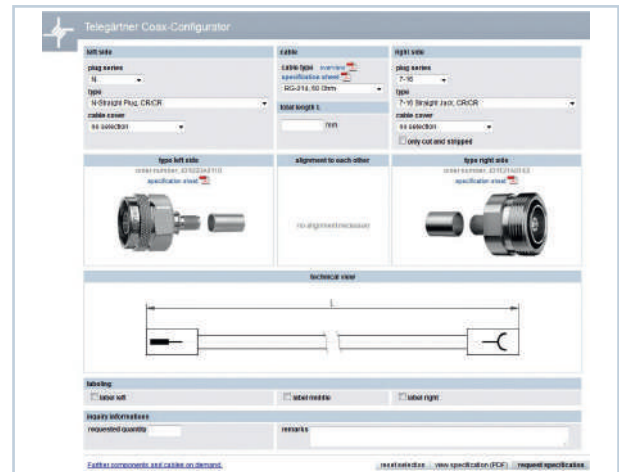

... and creation of a clear specification (PDF)



⇒ for individually assembled RF cables



Telegärtner
Karl Gärtner GmbH

Lerchenstr. 35
D-71144 Steinenbronn

Telefon: +49 (0) 71 57/1 25-0
Telefax: +49 (0) 71 57/1 25-5120

E-Mail: info@telegaertner.com
Web: www.telegaertner.com